

# A00023-B-8384

\* ITEM DIAGRAM IS SHOWN AT 30% OF ACTUAL SIZE \*

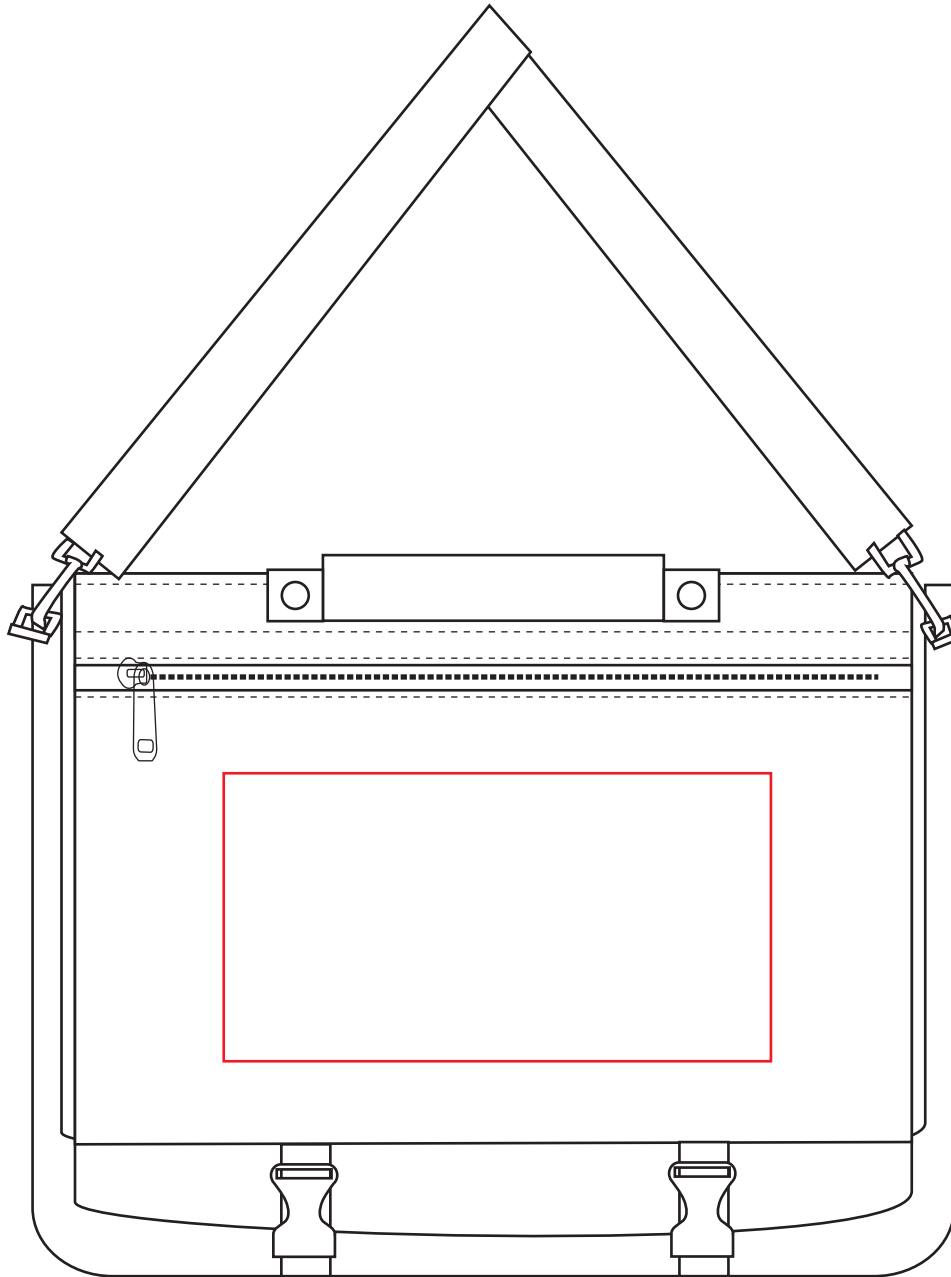

9.50" W x 5.00" H  
SCREEN PRINT  
AVAILABLE IMPRINT AREA